



Carbon credit earned by some designs of solar stills

Shiv Kumar^{a,*}, Khaled T. Kurmaji^b

^aMechanical Engineering Department, DTTE, Delhi, India

Tel. +91 9868878227; email: skdubey_1966@rediffmail.com

^bMechanical Engineering Department, College of Engineering, Zawia University, Zawia, Libya

Received 14 February 2012; Accepted 30 October 2012

ABSTRACT

This paper presents the theoretical analysis of CO₂ emission/mitigation and carbon credit earned by different designs of solar still in India. Numerical computation is performed on the basis of experimental performance of the solar stills, reported by various researchers. Estimation of carbon credits, which will accrue to the nation, is carried out for an expected system life span of 20 years and accounting 250, 275, and 300 clear days during a year. Return on the investment on the basis of life cycle cost analysis has also been carried out accounting carbon trading in the European market. It is found that the annual cash flow due to the carbon trading decrease the cost of production of distillate by Rs. 0.15 per liter with current carbon trading rate €2.10 per ton.

Keywords: Solar still; CO₂ emission; CO₂ mitigation; Carbon credit

1. Introduction

Good quality of water is a basic necessity of human beings for the survival. If current water consumption trends persist, by 2025, the demand of fresh water is expected to rise by 56% which is more than the amount of water that is currently available. Now a days, 1/3rd of global population faces water shortage and it is expected that by 2025, 2/3rd of humanity will face shortage of water, as estimated by the UN and the USA [1]. The demand for good quality of drinking water is increasing steadily and is a major problem in many developing countries. India's huge and growing population is putting a severe strain on all our natural resources. Most water sources are contaminated by sewage and agricultural runoff. Desalination has become one of the important methods that play an important role in solving fresh water

scarcity in different regions of the world. One of the promising options for eliminating the major operating cost of the distillation plant is direct use of the solar energy. Large quantity of energy is required to evaporate unit kg of water (2.25 MJ/kg). High energy billing represents one of the major contributions for the desalinated water cost. Desalination technologies have been used for about a century in land-based plants and on ships to provide water for the crews. The regular use of the desalination technologies accelerated after World War II due to raised demand of fresh water in arid countries. The solar distillation is a technique to produce potable water at lower cost than the other available desalination processes for a certain amount of water to be produced (demand < 200 m³/day, [2]). Unlike other distillation methods, solar stills use the solar energy to distillate the water in an environmentally friendly manner. It is one of the technologies with better solution to reduce the problem of

*Corresponding author.

energy security and climatic change with almost negligible running cost. Solar still can be installed at any remote location without much problem and particularly, remote villages, which may be difficult to serve the power through the conventional power grid.

Single basin solar still is a popular solar device used to convert available brackish/saline or waste water into potable water. However, low distillate yield from the passive solar still (2.0–4.01/m² day) has been a major barrier in its commercialization. Fath et al. [2] presented an analytical study as well as thermal and economic comparisons between the single slope and pyramid-shaped solar still. They predicted that average daily yield from both the solar still was nearly same (2.61/m²) with higher efficiency of single basin solar still (33%) as compared with pyramid shape (30%). Kumar and Tiwari [3] presented the life cycle cost analysis of the single slope passive and hybrid photovoltaic (PVT) active solar stills, based on the annual performance at 0.05 m water depth in the basin. They found that the hybrid (PVT) active solar still produce higher yield about 3.5 times than the passive solar still in Indian climate. Badran et al. [4] studied the performance of a pyramid-shaped solar still augmented with a flat-plate collector and concluded that the mass of distillate was increased by 231% in the case of tap water as a feed and by 52% in the case of salt water as a feed. The productivity of the single basin solar still was augmented by integrating fins at the basin plate by Velmurugan et al. [5]. To enhance the productivity of the solar still, it was modified with fin, black rubber, sand, pebble, and sponges at the bottom. The yield was increased by about 53% when fins were integrated at the basin plate. Ismail [6] designed a simple transportable hemispherical solar still and evaluated the performance experimentally under outdoors of Dhahran climatic conditions. It was found that the daily distilled water output from the still ranged from 2.8 to 5.71/m² day. Sadineni et al. [7] studied weir-type inclined solar still to recover pure water from the rejected water of solar hydrogen production plant. The productivity was found to be increased by 20% using the solar still. The experimental performance of a parallel single and double glass solar still with separate condenser was studied by El-Bahi and Inan [8] with 4° glass cover tilt. The yield from the solar still with a separate condenser was increased almost by 70%. Dwivedi and Tiwari [9] carried out annual experimental performance for shallow basin single and double slope solar stills and reported the higher annual yield from the single basin solar still per m² basin area than the double slope solar still for Indian climatic condition.

Energy consumption of a country is one of the indicators of its socioeconomic development. Presently, per capita energy consumption in India is one of the lowest in the world. It is about 20% of that in China, about 25% of that in Brazil, about 7.0% of that in Russia, and about 3.8% of that in the USA [10–13]. To achieve per capita energy consumption equal to that of Brazil (which is still a developing country like India), the Indian energy production and consumption must be quadrupled. For energy, India depends on oil and gas imports, which account for over 65% of its consumption; this is likely to increase further considering the economic development, rise in living condition of people, and rising prices. Coal, which currently accounts for over 60% of India's electricity production, is the major source of emission of greenhouse gasses and that of acid rain. India will become the third biggest polluter in the world after the USA and China if we keep depending on coal as the main source of electricity in the years to come. India will exhaust its oil reserves in 22 years, its gas reserves in 30 years, and its coal reserves in 80 years. More alarmingly, the coal reserves might disappear in less than 40 years if India continues to grow at 8% a year [14]. Coal, oil, and gasses are currently the major source of emission of Greenhouse Gases (GHG's) and that of acid rains. Our earth is undoubtedly warming. The average global temperature rose to 0.74 ± 0.18°C during last century. The effect is very small on the urban heat island, estimated to account for less than 0.002°C of warming per decade since 1900. It is expected that during the twenty-first century, the global surface temperature is likely to rise a further 1.1–2.9°C for their lowest emission scenario and 2.4–6.4°C for their highest [15]. In 2010 nominal value of global warming (+0.53°C) ranks just ahead of those of 2005 (+0.52°C) and 1998 (+0.51°C), but not statistically significant [16]. This warming is due to the result of emissions of carbon dioxide and other GHG's from human activities including industrial processes, fossil fuel combustion, and changes in land use, such as deforestation etc. The emissions of carbon dioxide and other greenhouse gasses must be reduced to protect ourselves, the economy, and the land from the adverse effects of the climate change. To achieve this goal, the concept of Clean Development Mechanism (CDM) has come into vogue as a part of Kyoto Protocol. The CDM is an arrangement under the Kyoto Protocol allowing industrialized countries to invest in emission reducing projects in developing countries as an alternative to what is generally considered more costly emission reductions in their own countries. The developed country would be given credits (Carbon Credits) for meeting its emission reduction targets, while the

developing country would receive the capital and clean technology to implement the project. Developed countries that have exceeded the levels can either cut down emissions, or borrow or buy carbon credits from developing countries. The objective is the stabilization of GHG's concentrations in the atmosphere at a level that would prevent dangerous anthropogenic interference with the climate system. Table 1 presents the contribution of the GHG's in global warming.

The United Nations Framework Convention on Climate Change (UNFCCC) divides countries as given in Table 2.

- Annex I countries: industrialized countries and economies in transition
- Annex II countries: developed countries which pay for costs of developing countries
- Non Annex I countries: developing countries.

Developing countries such as India, Srilanka, Afghanistan, China, Brazil, Iran, Kenya, Kuwait, Malaysia,

Pakistan, Phillipines, Saudi Arabia, Sigapore, South Africa, UAE, etc. have no immediate restrictions under the United Nations Framework Convention on Climate Change (UNFCCC). However, the present energy scenario of most of the developing countries is alarming due to rapid depletion and accelerating prices of conventional fuels.

Solar distillation is an attractive alternative to reduce emission of the GHG's with the use of solar energy. The enhancement of the yield from the solar desalination system, in a certain locations, could be attained by a proper modification in the system design. In this paper, 11 different design configurations (Table 3) with higher and lower values of yield are being considered to investigate the CO₂ mitigation by each.

CO₂ emission, mitigation, and carbon credit analysis of different design configurations of solar still have been essential to evaluate the benefit of modifications from the economical point of view. The main objective of this paper is;

Table 1
Contribution of GHG's for the global warming [17]

CO ₂	CH ₄	CFCs	N ₂ O
GWP ≈ 1	GWP ≈ 25	GWP ≈ 10–15,000	GWP ≈ 230
Contribution to warming 57%	Contribution to warming 20%	Contribution to warming 15%	Contribution to warming 6%
25% increase in last 100 years			
50% increase in next 50 years			

Table 2
Annex I and II countries

Annex I countries			Annex II countries	
Australia	Hungary	Poland	Austria	Luxembourg
Austria	Iceland	Portugal	Belgium	Netherlands
Belarus	Ireland	Romania	Canada	New Zealand
Belgium	Italy	Russian	Denmark	Norway
Bulgaria	Japan	Federation	Finland	Portugal
Canada	Latvia	Slovakia	France	Spain
Croatia	Liechtenstein	Slovenia	Germany	Sweden
Czech	Lithuania	Spain	Greece	Switzerland
Republic	Luxembourg	Sweden	Iceland	United Kingdom
Denmark	Malta	Switzerland	Ireland	United States of America
Estonia	Monaco	Turkey	Italy	
Finland	Netherlands	Ukraine	Japan	
France	New Zealand	United		
Germany	Norway	Kingdom		
Greece		United States of America		

Table 3
The different designs of solar stills

Ref. number	Denomination used in figures	Type of solar still
Fath et al. [2]	Ia	Single slope passive solar still with 23° cover tilt and area 1.5m ²
Kumar and Tiwari [3]	IIa	Single slope passive solar still with 30° cover tilt and area 1m ²
Kumar and Tiwari [3]	IIb	Single slope hybrid (PVT) active solar still and area 1m ²
Fath et al. [2]	Ib	Pyramid type passive solar still and area 1.5m ²
Badran et al. [4]	III	Pyramid type active (FPC) solar still and area 1m ²
Velmurugan et al. [5]	IV	Basin type passive solar still with fins and area 1m ²
Ismail [6]	V	Transportable hemisphere type passive solar still
Sadineni et al. [7]	VI	Weir-type passive solar still and area 1m ²
El-Bahi and Inal [8]	VII	With separate condenser and area 1m ²
Dwivedi and Tiwari [9]	VIIIa	Single slope shallow basin passive solar still with 15° cover tilt and area 1m ²
Dwivedi and Tiwari [9]	VIIIb	Double slope shallow basin passive solar still and area 2m ²

- to evaluate the annual yield for the different clear sunshine days in a year,
- to estimate the CO₂ emission, mitigation, and carbon credit earned by the different design of solar still for expected life time, and
- to estimate the affect of carbon trading on the water production cost of yield.

2. Analysis

Fig. 1 shows the schematics of different designs of solar stills under consideration. The different cover inclinations and basin size are given in Table 3.

2.1. CO₂ emission

Amount of CO₂ emitted during the fabrication of the distillation unit. Once the unit is fabricated, the same will be countable for the entire life time of the system. The average carbon dioxide emission for electricity generation from coal-fired power plants in European countries is approximately 0.98 kg of CO₂ per kWh (Watt et al. [18]). In addition, if the transmission and distribution losses for Indian condition are taken to be 40% and domestic appliances losses are around 20%, then the estimated value 0.98 is to be taken as 1.58. Therefore, annual carbon dioxide emission per year is expressed by Eq. (1).

$$\text{Annual CO}_2 \text{ emission} = \frac{E_{in} \times 1.58}{n} \quad (1)$$

where E_{in} and n are the embodied energy (kWh) and life span (years) of the system, respectively.

Embodied energy is the total energy consumed in manufacturing of the product. In addition to

energy required for material production, energy investment in procuring the equipment and operation during the various manufacturing stages includes; the process fuels, maintenance, the labor, research and development, and administrative activity. However, the energy investment in procuring the equipment and operation is very less and has been neglected in the analysis. The embodied energy of solar stills has been evaluated by multiplying mass of each component with their energy density [3] as given in Eq. (2).

Hence, CO₂ emission (tons) over the life time

$$= \frac{E_{in} \times 1.58}{1000} \quad (2)$$

2.2. CO₂ mitigation

The amount of CO₂ mitigated per year is given as Eq. (3).

The CO₂ mitigation (kg of CO₂) per year

$$= E_{out} \times 158 \quad (3)$$

where E_{out} is the annual energy (kWh) available from the solar still as a distillate yield and can be expressed [3] as Eq. (4).

$$E_{out} = \frac{M_Y \times L}{3600} \quad (4)$$

Therefore, the total and net CO₂ mitigation (in tons) over the life time (n) of the system are, respectively, presented by Eqs. (5) and (6).

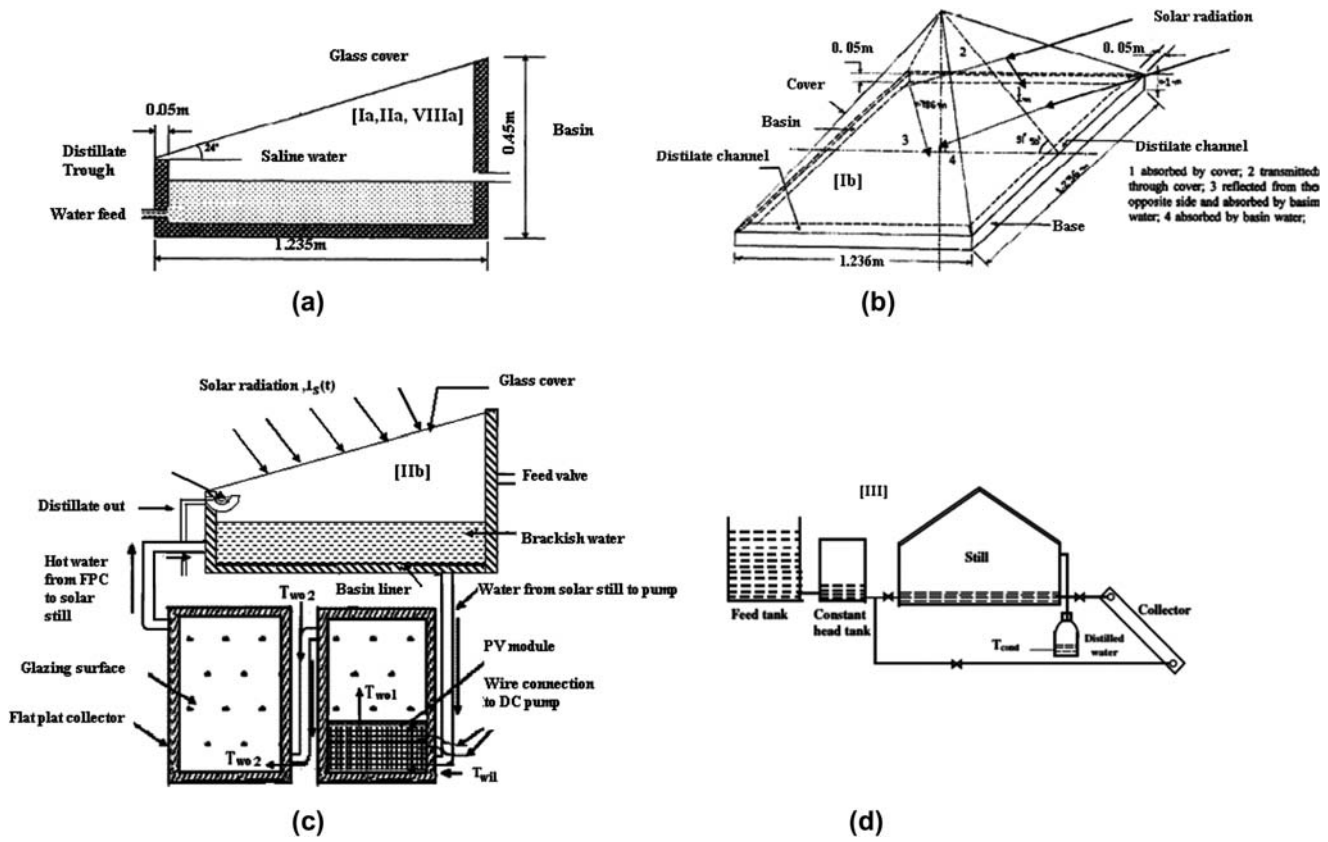

Fig. 1. Schematic of solar stills under present study.

CO₂ mitigation (tons) over life time =

$$\frac{E_{out} \times n \times 1.58}{1000} \quad (5)$$

Net CO₂ mitigation (tons) over life

$$= (E_{out} \times n - E_{in}) \times 1.58 \times 10^{-3} \quad (6)$$

where L is the latent heat of evaporation (kJ/kg) and M_Y is the annual yield (l).

2.3. Economics

The utilization of the solar stills as a source of distilled water for commercial purpose should be determined by its economics. The better economic return of the investment depends on the production cost of the distilled water. The uniform end of annual costs (UA) for a given initial investment (P_s) of solar distillation systems can be written as [3].

$$UA = P_s \times F_{CR,i,n} + (P_s \times F_{CR,i,n}) \times M_s - S_s \times F_{SR,i,n} \quad (7)$$

Here,

$$F_{CR,i,n} = \frac{i(1+i)^n}{(1+i)^n - 1}$$

and, $F_{SR,i,n} = \frac{i}{(1+i)^n - 1}$

2.3.1. Production cost (CPL)

The cost of distilled water per liter (CPL) based on annual yield can be calculated by dividing the annualized cost of the system with annual yield of the solar still and is expressed in Eq. (8).

Therefore,

$$CPL = \frac{UA}{M_Y} \quad (8)$$

2.3.2. Carbon credit

Carbon credits are defined as “a key component of national and international emissions trading schemes that have been implemented to mitigate global warming”. An international treaty such as the Kyoto Protocol set quotas on the amount of GHG’s which the signatory countries can produce. The trading of carbon credits was, therefore, created to curb the effect of

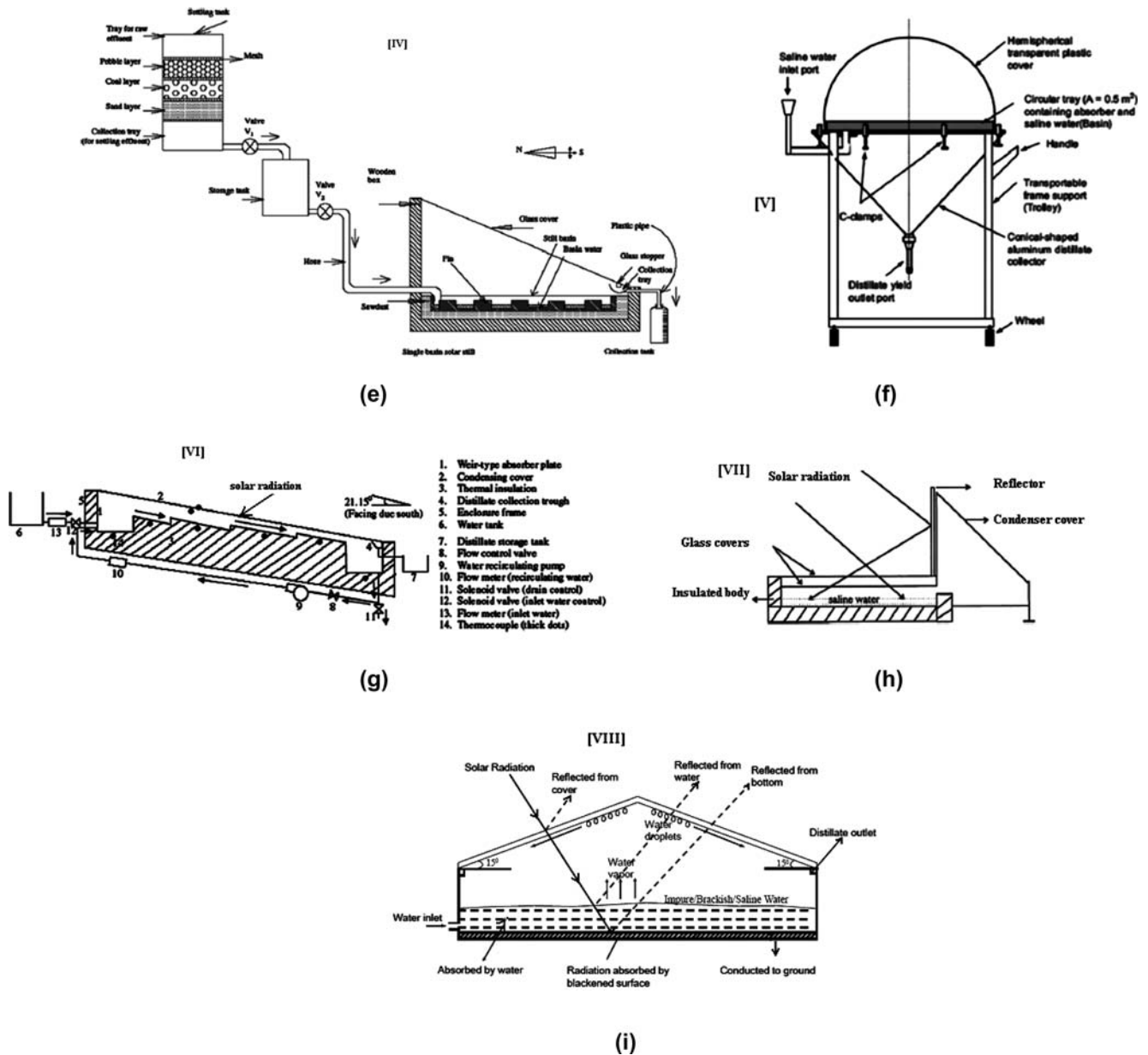

Fig. 1. (Continued)

greenhouse gases by reducing the carbon footprint. Credits can be exchanged between businesses or bought and sold in international markets at the prevailing market price. Credits can be used to finance carbon-reduction schemes between trading partners around the world.

There are currently two exchanges for bought and sold of carbon credits: the Chicago climate exchange and the European climate exchange. European and Japanese companies were the major buyers and China was the major seller of the carbon credits in 2005–2006. The market rate is fluctuating at €15–20 per ton of CO₂ mitigation in the European climate exchange [19] in 2007.

However, CDM has suffered record drop in prices of carbon trading during the current years. Currently, it has been traded at €2.10 per ton in Sep. 2012 (http://www.revistadae.com.br/novosite/noticias_interna.php?id=7168). So, the carbon credit earned by the system in terms of Indian currency (€ 1 = Rs. 70 in 2012) for entire life span and annually for the system are, respectively, expressed by Eqs. (9) and (10).

Net carbon credit earned (Rs.),

$$CCE = (E_{out} \times n - E_{in}) \times 1.58 \times 10^{-3} \times 2.10 \times 70 \quad (9)$$

Net annual carbon credit earned (Rs.),

$$CCE_Y = \frac{CCE}{n} \tag{10}$$

Energy payback time (EPBT) is defined as the time required to recover the energy invested in the system. EPBT of the solar stills can be evaluated by using the Eq. (11).

Energy payback time (year),

$$EPBT = \frac{E_{in} \times 3600}{M_Y \times L} \tag{11}$$

Annual cash flow (CF) per liter of yield due to carbon trading is expressed as Eq. (12).

CF due to carbon trading (Rs./liter of yield)=

$$\frac{CCE_Y}{M_Y} \tag{12}$$

Net production cost per liter of distillate,

$$CPL_{net} = CPL - CF \tag{13}$$

3. Results and discussion

Embodied energy used to fabricate the respective solar still is shown in Fig. 2. The variation of the energy is found due the different size, shape, and material of the solar stills. The highest embodied energy is estimated for hybrid (PVT) solar still around 3,689 kWh due to the PV integrated collectors.

The maximum solar radiation falls during a year over the glass cover with angle of inclination is about latitude of the experimental place of respective solar still during summer for per m² of basin area as shown in Fig. 3. The maximum solar radiation occurs in weir-type inclined solar still [6], where the solar radiation is about 1,000 W/m² during the typical day (8 Sep. 2008) on an inclined glass cover during clear sunshine. The average and maximum daily productivity of the different solar stills is also depicted in Fig. 3.

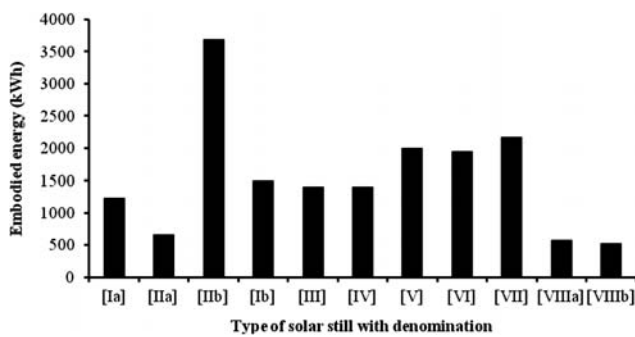

Fig. 2. Embodied energy of different designs of solar stills.

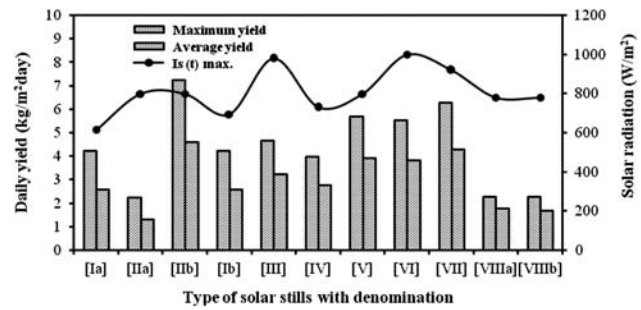

Fig. 3. Solar radiation and daily yield from different solar stills.

The maximum yield (7.25 liter/day) during the peak summer day is obtained from hybrid (PVT) active solar still and the lowest from passive solar still of single slope (2.25 liter/day) on a typical summer day in India. The maximum solar still productivity occurs in hybrid (PVT) single slope and parallel double glass solar still with separate condensing cover, where the solar radiations are about 850 and 920 W/m², respectively. The average daily yield of 4.71/m² has been estimated for the hybrid (PVT) active solar still. The average yield from these designs is used further to evaluate the CO₂ mitigation and carbon credit earned.

Fig. 4 shows the average annual productivity estimated from different types of solar stills for different clear sunshine days in a year. The results are based on the average daily yield obtained from annual experimental data recorded during clear days in each month (i.e. \sum [daily experimental yield in each month on experimental day]/12). It has been found that error values range from 2.2 to 4.1% from the total cumulative yield obtained experimentally for the number of clear days in each months separately (i.e. \sum [daily experimental yield \times Number of clear days in that month]/total number of clear days in a year). The results show that higher average annual productivity for a solar still is about 1,400 and 1,290 l/m² from the solar still reported as [IIIb] and [VII], respectively, accounting 300 clear days in a year. The lowest annual productivity is about 400 l/m² using single slope passive solar stills [IIa]. The yield from the double slope shallow basin solar still is higher in summer than the passive solar still. However, annual yield has been estimated less than the single slope shallow basin solar still for 0.01 m water depth in the basin.

Fig. 5 shows the life time CO₂ mitigation by different designs of solar still evaluated by using Eqs. (3)–(5), for different number of clear days. The expected life of 20 years for each solar still is taken into account. Maximum mitigation of CO₂ is found to be for hybrid (PVT) solar still (i.e. 33 tons). To evaluate the CO₂

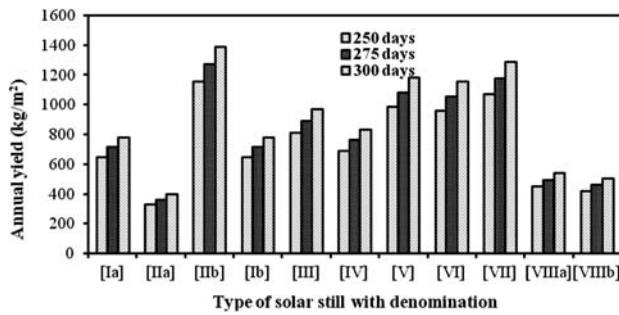

Fig. 4. Annual yield for the different types of solar stills for different numbers of clear days.

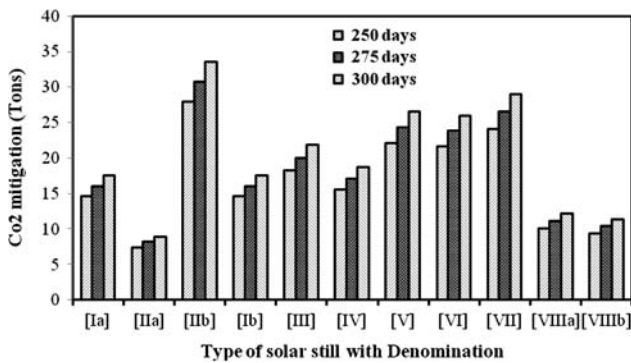

Fig. 5. CO₂ mitigation by different solar stills for different number of clear days.

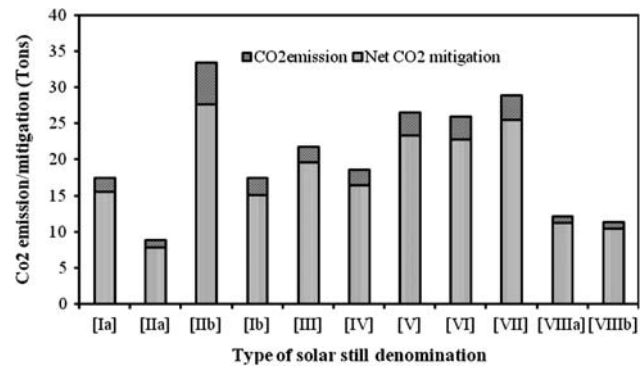

Fig. 6. CO₂ emission and net mitigation for different types of solar stills for 300 clear days.

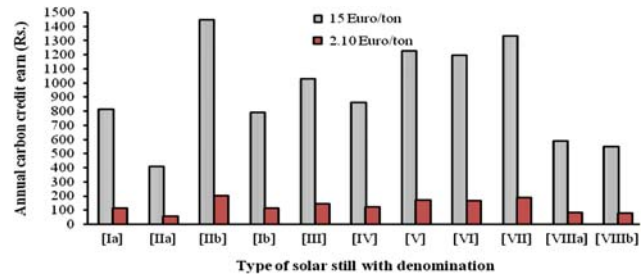

Fig. 7. Annual carbon credit earned by solar stills for 300 clear days.

emission that releases in the environment during fabrication of the units, Eqs. (1) and (2) are used. Embodied energy required to fabricate the solar still are reported as 659, 3,689, 572, and 521 kWh for passive single slope [IIa], hybrid single slope [IIb], passive shallow single slope [VIIIa], and double slope solar still [VIIIb], respectively. The net CO₂ mitigation evaluated by using Eq. (6) for the different design of solar still over the life span of 20 years is depicted in Fig. 6. The net CO₂ mitigated by solar still [IIb] and [VII] is found to be maximum and is about 26 tons over the life time. This reveals that if such 1,000 units are installed in remote areas, it will mitigate about 26,000 tons of carbon during their operational life span and yield about 1,400 m³/year.

Fig. 7 shows the variation of net annual carbon credit earned from 2007 to 2012, due to carbon trading, evaluated using Eqs. (9)–(12).

The annual CF (Rs. 1,300/-) is found to be highest in hybrid (PVT) active solar still in 2007 and drops down to Rs. 203 in the year 2012. However, it is found that CF per liter of yield obtained from different design is in the range of Rs. 0.14–Rs.0.15 and averaged as 0.15 Rs./liter irrespective of design as depicted in

Fig. 8 for current European market rate of € 2.10 per ton. The energy payback time is found to be minimum (1.6 years) for the single and double slope passive solar still operated on shallow depth and maximum (4 years) for the hybrid (PVT) active solar still.

The CF earned annually by the country due to carbon trading in global market will reduce the production cost of distillate as depicted in Fig. 9. Therefore,

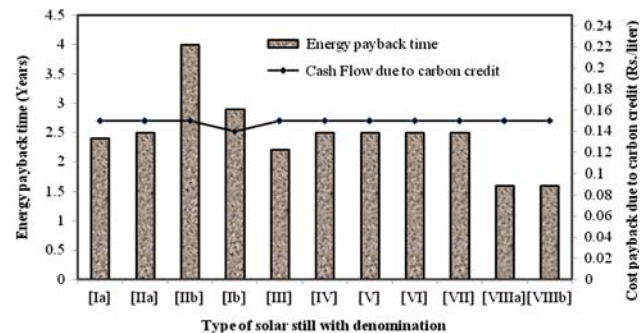

Fig. 8. Energy payback period and cost payback by the referenced solar still.

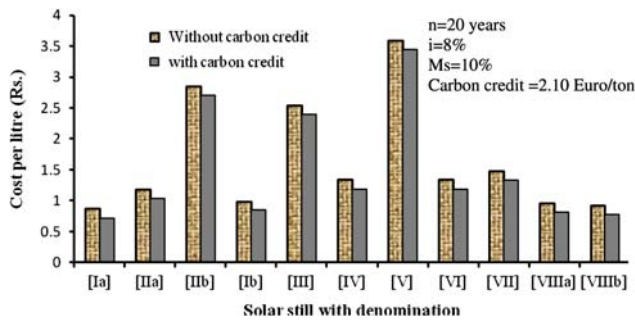

Fig. 9. Effect of carbon credit on production cost of different designs of solar still.

cost of production of potable water will be negligible and almost zero in some cases; depends on the initial investment, interest rate over the finance [2], and rate of carbon trading.

The results obtained show that best water production cost for a solar still is in the range of Rs. 0.72–0.81 per liter using single slope passive solar still. Cost of production from double slope solar still that operates on shallow water depth is found to be Rs. 0.78 per liter and slightly lower than the single slope solar still (Rs.0.81 per liter). Hybrid (PVT) active [IIIb], Pyramid type with solar collector [III], and transportable hemispherical [V] solar stills give the maximum water production cost around Rs. 2.7, 2.4 and 3.44 per liter, respectively.

4. Conclusions

From the above review, the CO₂ emission/mitigation and carbon credit earned by the different modified solar stills used to improve the yield have been analyzed for the Indian scenario by using several values from previous studies in different countries. The following conclusions could be drawn;

- (i) The best average and maximum daily productivity are obtained from the hybrid (PVT) active solar still. The average annual productivity obtained is 1,400 and 1,290 l/m² from the hybrid (PVT) active and weir-type solar stills, respectively.
- (ii) The net CO₂ mitigation is found to be maximum and is about 26 tons/m² by the hybrid (PVT) active and weir-type solar stills over a life time of 20 years.
- (iii) The CF earned annually due to carbon trading in global market will reduce the production cost of the distillate (CF Rs. 0.15 per liter of yield). However, it depends further on the future rates of carbon trading that varies glob-

ally and annually. The lowest production cost is found to be for basin-type passive solar stills (about Rs. 0.72–0.81 per liter) and maximum for transportable hemispherical solar stills (about Rs. 3.44 per liter).

Nomenclature

$F_{SR,i,n}$	—	Sinking fund factor
$F_{CR,i,n}$	—	capital recovery factor
i	—	interest rate
M_s	—	maintenance cost (%)
M_y	—	annual yield (liter)
n	—	expected life of solar still (years)
P_s	—	net present cost of the solar still (Rupees)
S_s	—	salvage value (Rupees)
UA	—	uniform end of annual cost (Rupees)

References

- [1] M.K. Gaur, Development of heat and mass transfer coefficients/correlations for high performance solar distillation systems [PhD thesis]. Delhi, India: IIT, (2010).
- [2] H.E.S. Fath, M. El-Samanoudy, K. Fahmy, A. Hassabou, Thermal-economic analysis and comparison between pyramid shaped and single-slope solar still configurations, *Desalination* 159 (2003) 69–79.
- [3] S. Kumar, G.N. Tiwari, Life cycle cost analysis of single slope hybrid (PVT) active solar still, *Appl. Energy* 86 (2009) 1995–2004.
- [4] A.A. Badran, A.A. Al-Hallaq, I.A. Eyal Salman, M.Z. Odat, A solar still augmented with a flat-plate collector, *Desalination* 172 (2005) 227–234.
- [5] V. Velmurugan, C.K. Deenadayalan, H. Vinod, K. Srithar, Desalination of effluent using fin type solar still, *Energy* 33 (2008) 1719–1727.
- [6] B.I. Ismail, Design and performance of a transportable hemispherical solar still, *Renewable Energy* 34 (2009) 145–150.
- [7] S.B. Sadineni, R. Hurt, C.K. Halford, R.F. Boehm, Theory and experimental investigation of a weir-type inclined solar still, *Energy* 33 (2008) 71–80.
- [8] A. El-Bahi, D. Inan, Analysis of a parallel double glass solar still with separate condenser, *Renewable Energy* 17 (1999) 509–521.
- [9] V.K. Dwivedi, G.N. Tiwari, Annual energy and exergy analysis of single and double slope solar stills, *Trends Appl. Sci. Res.* 3(3) (2008) 225–241.
- [10] Brazilian energy balance, 2012; (https://ben.epe.gov.br/downloads/Relatorio_Final_BEN_2012.pdf) p. 128, Table 7.1.
- [11] D. Spreng, Distribution of energy consumption and the 2000W/capita target, *Energy Policy* 33(15) (2005) 1905–1911.
- [12] P. Ward, G. Shively, Vulnerability, income growth and climate change, *World Dev.* 40(5) (2012) 916–927.
- [13] Prabhakant, G. N. Tiwari, Evaluation of carbon credits earned by energy security in India, *Low Carbon Technol.* 4(1) (2009) 42–51.
- [14] R. Kalshian, Energy vs. emissions: The big challenge of the new millennium, by Info Change News & Features. [cited 2008 March 21]. Available from: www.infochangeindia.org/agenda5_01.jsp.
- [15] Kevin E. Trenberth, Philip D. Jones, Observations: Atmospheric Surface and Climate Change, Urban Heat Islands and Land Use Effects, pp. 252–253, <http://www.ipcc.ch/pdf/assessment-report/ar4/wg1/ar4-wg1-chapter3.pdf> (Chapter 3).
- [16] World Meteorological Organization, WMO statement on the status of the global climate in 2010. WMO No. 1074, 1–15. (http://www.wmo.int/pages/publications/showcase/documents/1074_en.pdf).

- [17] S. Solomon, D. Qin, M. Manning, Z. Chen, M. Marquis, K. B. Averyt, M. Tignor, H.L. Miller, IPCC Climate Change: The Physical Science Basis, Contribution of Working Group I to the Fourth Assessment Report of the Intergovernmental Panel on Climate Change, Cambridge University Press, Cambridge, pp. 996, 2007.
- [18] M. Watt, A. Johnson, M. Ellis, H. Outhred, Life cycle air emission from PV power systems, *Prog. Photovoltaic. Res. Appl.* 6 (1998) 127–137.
- [19] Anon, European Climate Exchange (2007). (www.europeanclimateexchange.com).